

BRIKA



Schröder



# BRIKA



## CHARACTERISTICS - LUMINAIRE

|                            |  |
|----------------------------|--|
| Luminaire tightness level: | IP 66 <sup>(*)</sup>   |
| Impact resistance:         | IK 08 <sup>(**)</sup>  |
| Nominal voltage:           | 230 V - 50 Hz  |
| Electrical class:          | I or II <sup>(*)</sup>   |
| Weight:                    | from 2.8 to 4.7 kg   |
| Materials:                 |  |
| Body:                      | Extruded aluminium profiles and anti-UV synthetic material for the side cover accesses |
| Protector:                 | Glass  |
| Colour:                    | Anodised aluminium or painted RAL on request   |

<sup>(\*)</sup> according to IEC - EN 60598

<sup>(\*\*)</sup> according to IEC - EN 62262

## KEY ADVANTAGES

- Scalable in size and flux levels - from 2,600 to 4,900 lm
- A beneficial LED alternative to replace 36W fluorescent and 70W high-pressure sodium lamps
- Designed to withstand a wide ambient temperature range: Ta from -15°C to 50°C
- Excellent thermal conductivity
- Based on proven LensoFlex®2 photometrical engines
- Energy savings of up to 65% compared with traditional sources
- Surge protection 10kV

## SMALL, EFFICIENT AND FLEXIBLE

The Brika range is scalable in size and flux level (steps of 8 LEDs) thanks to its extruded design. With 8 LEDs, the Brika luminaire is ideally suited to lighting secondary roads, car parks and campuses. With 24 LEDs, it is a proven beneficial LED alternative to 70W high-pressure sodium lamps for lighting residential districts and other city roads. The Brika range was developed with the goal of providing a performing LED luminaire with a minimum total cost of ownership. The Brika is not only an economical LED luminaire, its extensive photometry offers the guarantee of maximised energy savings.

## OPTIONS

- Warm white light 3000K

## DIMENSIONS

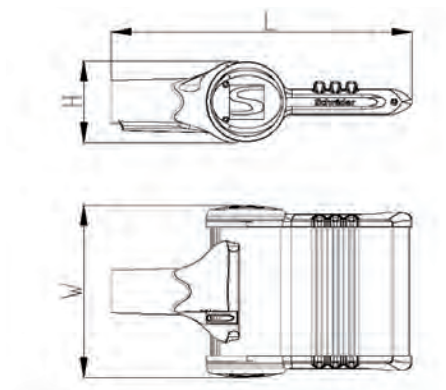

|   | 8 LEDs | 16 LEDs | 24 LEDs |
|---|--------|---------|---------|
| W | 216 mm | 301 mm  | 386 mm  |
| H | 103 mm | 103 mm  | 103 mm  |
| L | 378 mm | 378 mm  | 378 mm  |

## ENERGY SAVINGS OF UP TO 65%

Brika integrates the latest cutting edge solutions. It is equipped with high-power LEDs and performing drivers for a dramatic reduction in energy consumption. Brika offers a very competitive alternative to luminaires equipped with light sources such as fluorescent and high-pressure sodium lamps. With this favourable energy balance, the Brika contributes to the effective management of finances and to the responsible use of energy.

## PERFORMANCE AND MODULARITY

Thanks to photometric engines composed of modular quantities of LEDs, the Brika luminaire can offer a wide range of lumen packages up to 4,300 lm. This modularity ensures that the light distributions are adapted to the real needs of the area to be lit.

## RESISTS HIGH TEMPERATURES

The Brika luminaire is designed to operate reliably even in the hottest regions. Due to its extruded design, it achieves an excellent thermal conductivity. The Brika perfectly withstands high temperatures (Ta up to 50°C depending on the model) which enables it to be installed in regions with the warmest climates at night.

## LENSOFLEX®2

Brika luminaires are equipped with second generation LensoFlex®2 photometric engines that have been specifically developed for lighting spaces where the well-being and safety of people using the environments are essential. This system is based upon the addition principle of photometric distribution. Each LED is associated with a specific lens that generates the complete photometric distribution of the luminaire. It is the number of LEDs in combination with the driving current that determines the intensity level of the light distribution.

## IP 66 TO MAINTAIN PERFORMANCE OVER TIME

The optical compartment and the control gear are IP 66 sealed to protect the electronic components and the photometric engine from coming into contact with the outside environment and so maintain reliability and photometric performance over time.

An end cap on one side provides access to the control gear compartment.

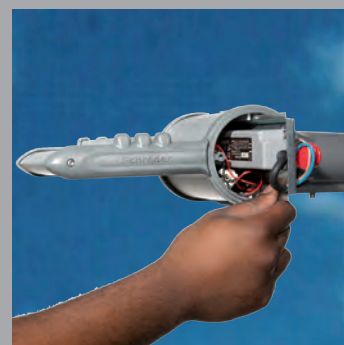
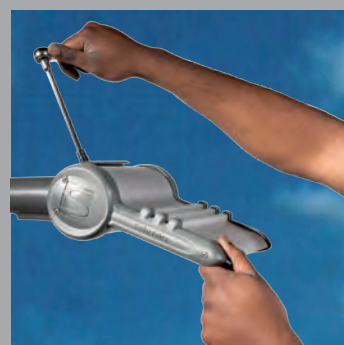
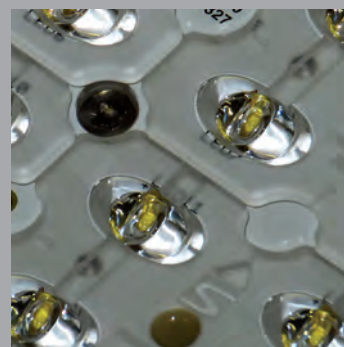
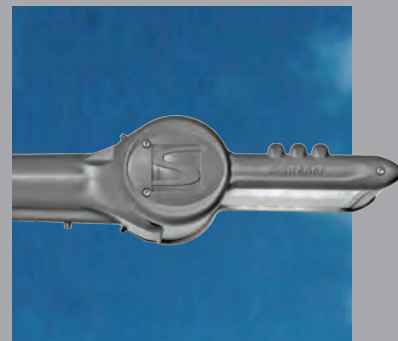

PHOTOMETRY

| Brika LensoFlex®2 |                       |        |         |         | Lifetime residual flux @ t <sub>a</sub> 35°C |
|-------------------|-----------------------|--------|---------|---------|--|
| Number of LEDs    | Neutral white (4000K) | 8 LEDs | 16 LEDs | 24 LEDs | @50.000h                                     |
| Current: 700mA    | Nominal flux (lm)*    | 2600   | -       | -       | 70%  |
|                   | Power consumption (W) | 19     | -       | -       |  |
| Current: 500mA    | Nominal flux (lm)*    | -      | 3100    | -       |  |
|                   | Power consumption (W) | -      | 27      | -       |  |
| Current: 530mA    | Nominal flux (lm)*    | -      | -       | 4900    |  |
|                   | Power consumption (W) | -      | -       | 42      |  |

(\*) The nominal flux is an indicative LED flux @ t<sub>a</sub> 25°C based on LED manufacturer's data. The real flux output of the luminaire depends on environmental conditions (e.g. temperature and pollution) and the optical efficiency of luminaire. Nominal flux depends on the type of LED in use and likely to change in accordance with the continuous and rapid developments in LED technology. To follow the progress of the luminous efficiency of the LEDs used, please visit our website.

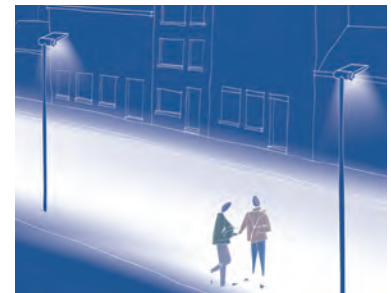
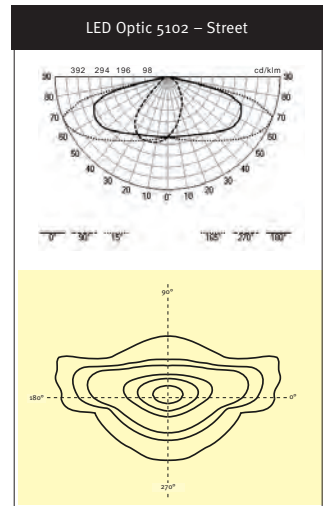

MOUNTING

SIDE-ENTRY POSITION

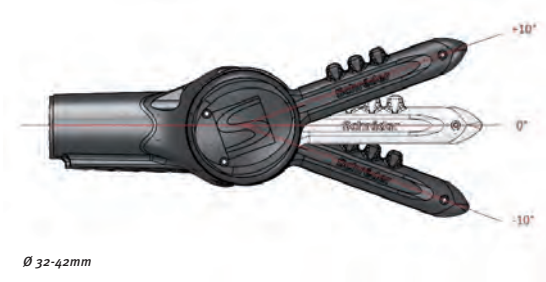

Inclination angles from +10° to -10° in steps of 5°

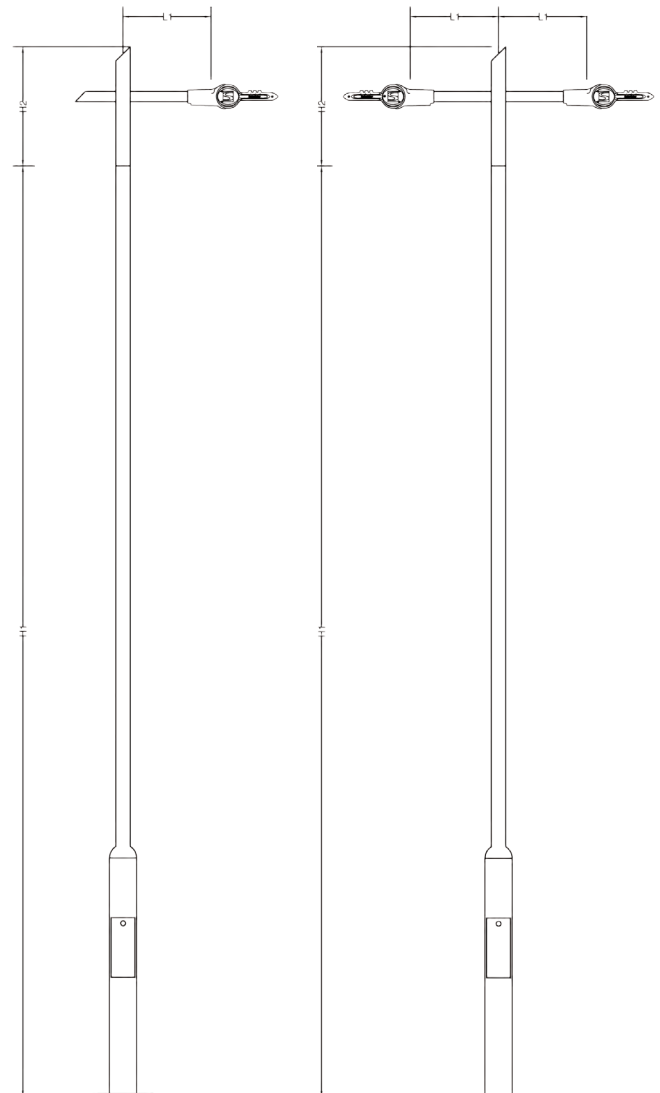

POLES AND BRACKETS

|    |                       |
|----|-----------------------|
| H1 | 4000 - 6000 mm        |
| H2 | 400 mm                |
| L1 | 300 mm (for 4 m pole) |
| L1 | 500 mm (for 6 m pole) |





SAFETY



WELL-BEING



SUSTAINABILITY



SAVINGS



SOLUTIONS

